



Owner's Manual and Instructions

Tradesman 170 and Tradesman 170 Ultra Construction Heaters



MODEL	OUTPUT (Btuh)	FUEL
CP170	170,000	Propane Vapor Withdrawal
	155,000	Natural Gas

Certification by:



Congratulations!

You have purchased the finest portable forced air construction heater available.

Your new L.B. White heater incorporates the benefits from the most experienced manufacturer of heating products using state-of-the-art technology.

We, at L.B. White, **thank you** for your confidence in our products and welcome any suggestions or comments you may have...call us, toll-free, at (800) 345-7200.

ATTENTION ALL USERS

This heater has been tested and evaluated by C.S.A. International in accordance with the requirements of Standard ANSI Z83.7• CSA 2.14 and is listed and approved as a direct gas-fired forced-air construction heater with application for the temporary heating of buildings under construction, alteration, or repair. If you are considering using this product for any application other than its intended use, then please contact your fuel gas supplier, or the L.B. White Co., Inc.



Quality heaters you can count on.

W6636 L.B. White Rd., Onalaska, WI 54650 ■ (800) 345-7200 ■ (608) 783-5691 ■ (608) 783-6115, fax ■ info@lbwhite.com

150-27724



GENERAL HAZARD WARNING

- Failure to comply with the precautions and instructions provided with this heater, can result in:
 - Death
 - Serious bodily injury or burns
 - Property damage or loss from fire or explosion
 - Asphyxiation due to lack of adequate air supply or carbon monoxide poisoning
 - Electrical shock
- Read this Owner's Manual before installing or using this product.
- Only properly-trained service people should repair or install this heater.
- Save this Owner's Manual for future use and reference.
- Owner's Manuals and replacement labels are available at no charge. For assistance, contact L.B. White at 800-345-7200.



WARNING

- Proper gas supply pressure must be provided to the inlet of the heater.
- Refer to data plate for proper gas supply pressure.
- Gas pressure in excess of the maximum inlet pressure specified at the heater inlet can cause fires or explosions.
- Fires or explosions can lead to serious injury, death, or building damage.
- Gas pressure below the minimum inlet pressure specified at the heater inlet may cause improper combustion.
- Improper combustion can lead to asphyxiation or carbon monoxide poisoning and therefore serious injury or death.



WARNING

Fire and Explosion Hazard

- Not for home or recreational vehicle use.
- Installation of this heater in a home or recreational vehicle may result in a fire or explosion.
- Fire or explosions can cause property damage or loss of life.

FOR YOUR SAFETY

If you smell gas:

1. Open windows.
2. Don't touch electrical switches.
3. Extinguish any open flame.
4. Immediately call your gas supplier.

FOR YOUR SAFETY

Do not store or use gasoline or other flammable vapors and liquids in the vicinity of this or any other appliance.



WARNING

Fire and Explosion Hazard

- Keep solid combustibles a safe distance away from the heater.
- Solid combustibles include wood, paper, or plastic products, building materials and dust.
- Do not use the heater in spaces which contain or may contain volatile or airborne combustibles.
- Volatile or airborne combustibles include gasoline, solvents, paint thinner, dust particles or unknown chemicals.
- Failure to follow these instructions may result in a fire or explosion.
- Fire or explosions can lead to property damage, personal injury or loss of life.



Table of Contents

SECTION	PAGE
General Information	3
Heater Specifications	4
Safety Precautions	5
Installation and Assembly Instructions	
General	7
Propane Gas Supply Sizing	8
Handle Assembly	8
Hose and Regulator Assembly	9
Connecting Regulator to Propane Gas Supply Cylinder	9
Height Adjustment	10
Start-Up Instructions	11
Shut-Down Instructions	11
Variable Rate Valve	11
Cleaning Instructions	12
Maintenance Instructions	12
Service Instructions	
General	13
Motor, Fan, and Air Proving Switch	13
Auto Reset Limit Switches	14
Variable Rate Valve and Gas Control Valve	14
Igniter	15
Burner Orifice	15
Thermostat	16
Ignition Control	16
Gas Pressure Checks	17
Troubleshooting Information	18
Electrical Connection and Ladder Diagrams	26
Heater Component Function	27
Parts Identification	
Parts Schematic	28
Parts List	29
Warranty Policy	30
Replacement Parts and Service	30

General Information

This Owner's Manual includes all options and accessories commonly used on this heater.

When calling for technical service assistance, or for other specific information, always have model number, configuration number and serial number available. This information is contained on the dataplate.

This manual will instruct you in the operation and care of your unit. Have your qualified installer review this manual with you so that you fully understand the heater and how it functions.

The gas supply line installation, installation of the heater, and repair and servicing of the heater requires continuing expert training and knowledge of gas heaters and should not be attempted by anyone who is not so qualified. See page 6 for definition of the necessary qualifications.

Contact your local L.B. White distributor or the L.B. White Co., Inc. for assistance, or if you have any questions about the use of the equipment or its application.

The L.B. White Co., Inc. has a policy of continuous product improvement. It reserves the right to change specifications and design without notice.

Heater Specifications

SPECIFICATIONS

Model

CP170

Fuel Type	Propane Gas	Natural Gas
Maximum / Minimum Input (BTUH)	170,000 / 125,000	155,000 / 125,000
Burner Manifold Pressure (in. W.C.)	11.0	4.9
Inlet Gas Supply Pressure Acceptable at the Gas Connection of the Heater. (in. W.C.)	MAX.	11.1
	MIN.	11.1
Fuel Consumption Per Hour	7.87 lbs.	155 cu. ft.
Motor Characteristics	Sleeve Bearing 1/15 H.P., 3,200 RPM	
Electrical Supply (Volts/Hz/Phase)	115/60/1	
Amp Draw	STARTING	3.7
	CONTINUOUS OPERATION	2.14
Dimensions (Inches) L x W x H	24 x 9 x 16	
Minimum Safe Distances From Nearest Combustible Materials (feet)	TOP	6
	SIDES	3
	BACK	3
	BLOWER OUTLET	10
	GAS SUPPLY	6

Safety Precautions

WARNING **Asphyxiation Hazard**

- Do not use this heater for heating human living quarters.
- Do not use in unventilated areas.
- The flow of combustion and ventilation air must not be obstructed.
- Proper ventilation air must be provided to support the combustion air requirements of the heater being used.
- Lack of proper ventilation air will lead to improper combustion.
- Improper combustion can lead to carbon monoxide poisoning leading to serious injury or death. Symptoms of carbon monoxide poisoning can include headaches, dizziness and difficulty in breathing.

FUEL GAS ODOR

Propane gas and natural gas have man-made odorants added specifically for detection of fuel gas leaks. If a gas leak occurs, you should be able to smell the fuel gas. THAT'S YOUR SIGNAL TO GO INTO IMMEDIATE ACTION!

- Do not take any action that could ignite the fuel gas. Do not operate any electrical switches. Do not pull any power supply or extension cords. Do not light matches or any other source of flame. Do not use your telephone.
- Get everyone out of the building and away from the area immediately.
- Close all propane gas tank or cylinder fuel supply valves, or the main fuel supply valve located at the meter if you use natural gas.
- Propane gas is heavier than air and may settle in low areas. When you have reason to suspect a propane leak, keep out of all low areas.
- Use your neighbor's phone and call your fuel gas supplier and your fire department. Do not re-enter the building or area.
- Stay out of the building and away from the area until declared safe by the firefighters and your fuel gas supplier.
- **FINALLY**, let the fuel gas service person and the firefighters check for escaped gas. Have them air out the building and area before you return. Properly trained service people must repair the leak, check for further leakages, and then relight the appliance for you.

ODOR FADING -- NO ODOR DETECTED

- **Some people cannot smell well. Some people cannot smell the odor of the man-made chemical added to propane or natural gas. You must determine if you can smell the odorant in these fuel gases.**
- Learn to recognize the odor of propane gas and natural gas. Local propane gas dealers will be more than happy to give you a scratch and sniff pamphlet. Use it to become familiar with the fuel gas odor.
- Smoking can decrease your ability to smell. Being around an odor for a period of time can affect your sensitivity to that particular odor.
- The odorant in propane gas and natural gas is colorless and the intensity of its odor can fade under some circumstances.
- If there is an underground leak, the movement of gas through the soil can filter the odorant.
- Propane gas odor may differ in intensity at different levels. Since propane gas is heavier than air, there may be more odor at lower levels.
- **Always be sensitive to the slightest gas odor.** If you continue to detect any gas odor, no matter how small, treat it as a serious leak. Immediately go into action as discussed previously.

ATTENTION -- CRITICAL POINTS TO REMEMBER!

- Propane gas has a distinctive odor. Learn to recognize these odors. (Reference Fuel Gas Odor and Odor Fading sections above.)
- If you have not been properly trained in repair and service of propane gas then do not attempt to light heater, perform service or repairs, or make any adjustments to the heater on the propane gas fuel system.
- Even if you are not properly trained in the service and repair of the heater, **ALWAYS** be consciously aware of the odors of propane gas and natural gas.
- A periodic sniff test around the heater or at the heater's joints; i.e. hose, connections, etc., is a good safety practice under any conditions. If you smell even a small amount of gas, **CONTACT YOUR FUEL GAS SUPPLIER IMMEDIATELY. DO NOT WAIT!**



WARNING
Burn Hazard

- High surface and discharge temperatures.
- Do not touch the heater or come within safe clearances given on dataplate.
- Use extreme caution when lighting the heater or adjusting heat levels.
- Failure to follow this warning and come too close to the heater can result in burns or ignition of clothing.
- Burns cause serious injury or death.

1. Do not attempt to install, repair, or service this heater or the gas supply line unless you have continuing expert training and knowledge of gas heaters.

Qualifications for service and installation of this equipment are as follows:

- a. To be a qualified gas heater service person, you must have sufficient training and experience to handle all aspects of gas-fired heater installation, service and repair. This includes the task of installation, troubleshooting, replacement of defective parts and testing of the heater. You must be able to place the heater into a continuing safe and normal operating condition. You must completely familiarize yourself with each model heater by reading and complying with the safety instructions, labels, Owner's Manual, etc., that is provided with each heater.
 - b. To be a qualified gas installation person, you must have sufficient training and experience to handle all aspects of installing, repairing and altering gas lines, including selecting and installing the proper equipment, and selecting proper pipe and tank size to be used. This must be done in accordance with all local, state and national codes as well as the manufacturer's requirements.
 - c. In the Commonwealth of Massachusetts, this product must be installed by a gas fitter licensed by the Commonwealth of Massachusetts.
2. All installations and applications of L.B. White heaters must meet all relevant local, state and national codes. Included are L.P. gas, natural gas, electrical, and safety codes. Your local fuel gas supplier, a local licensed electrician, the local fire department or similar government agencies, or your insurance agent can help you determine code requirements.

Also refer to:

- ANSI/NFPA 58, latest edition, Standard for Storage and Handling of Liquefied Petroleum Gas
 - ANSI Z223.1/NFPA 54, National Fuel Gas Code
 - ANSI/NFPA 70, National Electrical Code.
3. Adequate ventilation air for combustion must be provided in accordance with OSHA 29 CFR 1926.154, Temporary Heating Devices, and ANSI A10.10, Safety Requirements for Temporary and Portable Space Heating Devices.
 4. We cannot anticipate every use which maybe made of our heaters. Check with the local fire safety authority if you have questions about applications.

5. Forced air heaters shall not be directed toward any propane gas container within 20 feet (6.10 meters).
6. Do not wash the heater. Use only compressed air, a soft brush or dry cloth to clean the interior of the heater and it's components.
7. Use only the regulator supplied with the heater. The heater must be regulated at all times for proper operation.
8. For safety, this heater is equipped with auto reset limit switches, and an air proving switch. Never operate the heater with any safety device that has been bypassed. Do not operate this heater unless these features are fully functioning.
9. Do not block air intakes or discharge outlets of the heater. Doing so may cause improper combustion or damage to heater components leading to property damage.
10. The hose assembly shall be visually inspected on a daily basis after heater relocation and when the heater is in use. If it is evident there is excessive abrasion or wear, or if the hose is cut, it must be replaced prior to the heater being put into operation. The hose assembly shall be protected from building materials, and contact with hot surfaces during use. The hose assembly shall be that specified by the manufacturer. See parts list.
11. Check for gas leaks and proper function upon heater installation, when relocating, and after servicing. Refer to leak check instructions within installation section of this manual.
12. This heater should be inspected for proper operation by a qualified service person before each use and at least annually.
13. Always turn off the gas supply to the heater if the heater is not going to be used in the heating of the work space.
14. This heater is equipped with a three-prong (grounding) plug for your protection against shock hazard and must be plugged directly into a properly grounded three-prong receptacle. Failure to use a properly grounded receptacle can result in electrical shock, personal injury, or death.
15. If gas flow is interrupted and flame goes out, do not relight the heater until you are that all gas that may have accumulated has cleared away. In any event, do not relight the heater for at least 5 minutes.
16. Minimum propane gas supply cylinder size to be used shall be 100 pounds when using a cylinder supply system. The system must be arranged to provide vapor withdrawal from the operating cylinder.
17. When the heater is to be stored indoors, the connection between the propane gas supply cylinder(s) and the heater must be disconnected and the cylinder(s) removed form the heater and stored in accordance with the Standard for the Storage and Handling of Liquefied Petroleum Gases, ANSI/NFPA 58.
18. Propane gas supply containers have left handed threads. Always use the appropriate wrench to make a connection to tighten or loosen the P.O.L. fitting at the cylinders' gas supply valve.

Installation and Assembly Instructions

GENERAL

WARNING

Fire and Explosion Hazard

Can cause property damage, severe injury or death

To avoid dangerous accumulation of fuel gas, turn off gas supply at the heater service valve before starting installation, and perform gas leak test after completion of installation.

1. Read all safety precautions and follow L. B. White recommendations when installing this heater. If during the installation or relocating of heater, you suspect that a part is damaged or defective, call a qualified service agency for repair or replacement.
2. Ensure the heater is properly positioned before use. The heater must be installed on a level, flat, and stable surface when in operation and according to minimum safe distances from combustible materials. Safe distances are given on the heater dataplate and on page 4 of this manual.
3. **L.P Gas Installation Requirements**
 - Ensure all L.P. gas containers are secured and protected from people, vehicular traffic and contact.
 - L.P. gas containers must be located on a flat, level, and stable surface.
 - L.P. gas cylinders (100 lb. cylinders/tanks) must be secured from tip-over.

Contact your local authorities, L.P. gas dealers, or fire marshalls for specifics dealing with installation in your area.
4. This heater is approved for indoor use only. The heater shall be installed so it is not directly exposed to water spray, rain, and /or dripping water.
5. The heater's gas pressure regulator (with pressure relief valve) must be protected from adverse weather conditions (rain, ice, snow) as well as from building materials (tar, concrete, plaster, etc.) which can affect safe operation and could result in property damage or injury.
6. Heaters used in the vicinity of combustible tarpaulins, canvas, plastics, wind barriers, or similar coverings shall be located at least 10 feet from the coverings. The coverings shall be securely fastened to prevent ignition or upsetting of the heater due to wind action on the covering or other material.
7. Insure that all accessories that ship with the heater have been and installed.

8. Check all connections for gas leaks using approved gas leak detectors. Gas leak testing is performed as follows:

WARNING

Fire and Explosion Hazard

- Do not use open flame (matches, torches, candles, etc.) in checking for gas leaks.
- Use only approved leak detectors.
- Failure to follow this warning can lead to fires or explosions.
- Fires or explosions can lead to property damage, personal injury or loss of life.

- Check all pipe connections, hose connections, fittings and adapters upstream of the gas control with approved gas leak detectors.
- In the event a gas leak is detected, check the components involved for cleanliness and proper application of pipe compound before further tightening.
- Tighten the gas connections as necessary to stop the leak.
- After all connections are checked and any leaks are stopped, turn on the main burner.
- Stand clear while the main burner ignites to prevent injury caused from hidden leaks that could cause flashback.
- With the main burner in operation, check all connections, hose connections, fittings and joints as well as the gas control valve inlet and outlet connections with approved gas leak detectors.
- If a leak is detected, check the components involved for cleanliness in the thread areas and proper application of pipe compound before further tightening.
- Tighten the gas connection as necessary to stop the leak.
- If necessary, replace the parts or components involved if the leak cannot be stopped.
- Ensure all gas leaks have been identified and repaired before proceeding.

9. A qualified service agency must check for proper operating gas pressure upon installation of the heater.
10. Always use pipe thread compound that is resistant to propane and natural gas.
11. Light according to instructions on heater or within owner's manual.

12. Make sure the heater has the proper gas regulator for the application. A regulator must be connected to the gas supply so that gas pressure at the inlet to the gas valve is regulated within the range specified on the dataplate at all times. Contact your gas supplier, or the L.B. White Co., Inc. if you have any questions.
13. This heater is configured for use for propane gas vapor withdrawal only. Do not use the heater in an propane gas liquid withdrawal system or application. If you are in doubt, contact the L.B. White Co., Inc.
14. The heater must be installed so as not to interfere with or obstruct normal exits, emergency exits, doors and walkways.
15. Railing, fencing or suitable substitute materials must be used to keep the heating equipment from any people using and visiting the structure.
16. Eventually, like all electrical/mechanical devices, the thermostat can fail. Thermostat failure may result in an underheating condition. The thermostat should be tested to make sure it turns the heater on and off within a temperature differential of $\pm 3^{\circ}\text{F}$.
17. Take time to understand how to operate and maintain the heater by using this Owner's Manual. Make sure you know how to shut off the gas supply to the building and also to the individual heater. Contact your fuel gas supplier if you have any questions.
18. Any defects found in performing any of the service or maintenance procedures must be eliminated and defective parts replaced immediately. The heater must be retested by properly qualified service personnel before placing the heater back into use.

PROPANE GAS SUPPLY SIZING

The vaporization of propane is affected by several factors: the surface area of the container, the liquid level of propane, temperature surrounding the container, and the relative humidity. All of these factors are specific to a site. Therefore, a degree of experience and judgement is required to select the proper propane supply. Although experience is the best guide, the following

recommendations can be used as a starting point. The table is based on experience during winter in northern climates. If more or less favorable conditions prevail at a specific site, adjustments can be made on the basis of experience.

Recommended Propane Gas Supply

Average Temp °F	50	40	30	20	10	0	-10
Number of 100lb. Gas Cylinders to Use Per Heater	2	2	3	3	3	3	3

* Cylinders must be manifolded together to allow simultaneous vapor withdrawal from all cylinders.

HANDLE ASSEMBLY

Assemble handle to four holes at barrel top as shown in Fig.1. Tighten screws securely.

FIG. 1



HOSE AND REGULATOR ASSEMBLY

Propane Gas

1. Connect rigid end of hose to regulator and tighten securely.
2. Install hose adapter to gas inlet of heater. Tighten adapter securely. Connect end of hose with nut to hose adapter. Tighten hose nut securely. See Fig 3.

FIG. 2



FIG. 3



Natural Gas

- Connect the components and regulator at the heater's gas inlet as shown in Fig. 4. Ensure flow arrow on regulator body is in direction of gas flow. Tighten all securely.

FIG. 4

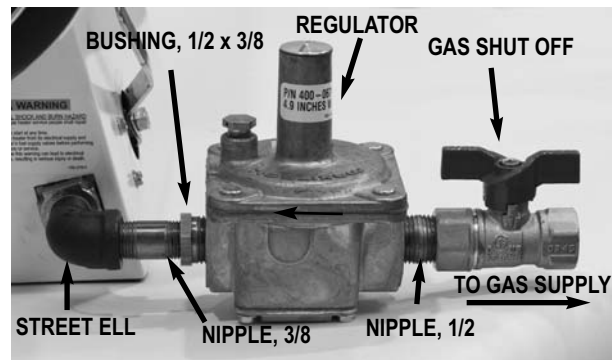

CONNECTING PROPANE REGULATOR TO PROPANE GAS CYLINDER

1. Ensure the cylinder valve is completely closed.
2. Remove the protective cap from regulator fitting. Do not discard cap.
3. Insert POL stem into the valve on the cylinder. Thread the nut counterclockwise into the tank valve. Ensure regulator vent is pointed down. Tighten the nut securely with a wrench. See Fig. 5.
3. Slowly open the cylinder valve by turning counterclockwise. This will prevent lock-up of the excess flow valve within POL stem.
4. Check all connections with approved leak detector. Do not use flame to check for leaks. A fire or explosion may result.
5. When storing or transporting the heater, ensure the cap is pushed back onto the POL fitting. This will protect the fitting from damage and prevent entry of dirt.

FIG. 5

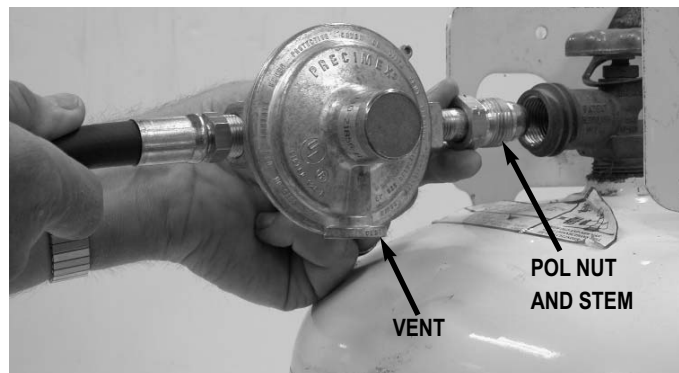

HEIGHT ADJUSTMENT

This heater includes a height adjustment feature, allowing the user to change the elevation of the heater for greater heat direction. See Fig. 6 for location of adjustment on front base of heater.

FIG. 6

To adjust the heater's discharge outlet height (See Fig.6):

- Loosen knob
- Lift heater slightly at blower outlet end
- Pull leg to desired setting
- Tighten knob.

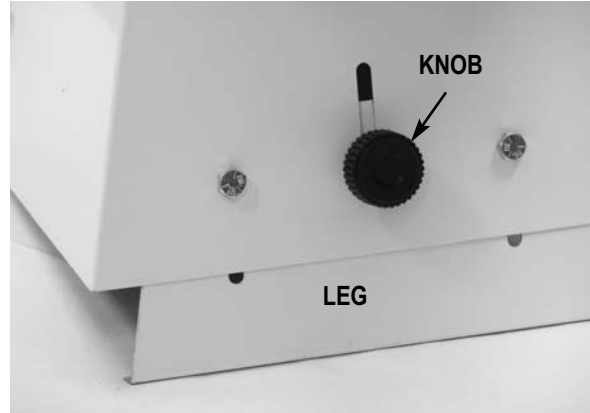

WARNING **Burn Hazard**

- Do not adjust height while heater is operating or hot.
- Adjust height only after the heater has been disconnected from its power supply and cool to touch.
- Failure to follow this warning will result in burns causing injury.

Start-Up Instructions

1. Connect the heater's electrical cord to an approved electrical outlet.
 2. Open the gas supply valve. For LP heaters, this is located on the tank.
 3. Set thermostat on heater to a setting above room temperature. The heater will start and the burner will ignite.
- It is normal for air to be trapped in gas hose on new installations. You may need to recycle the heater before air is finally purged from the line and ignition takes place.
4. Do not exceed input rating provided on dataplate or manufacturer's recommended burner manifold pressure for size orifice used. Ensure that the primary air supply to heater is open and free of dust, dirt and debris for complete, proper combustion.

Shut-Down Instructions

If the heater is to be shut down for cleaning, maintenance, or repair, follow steps 1-4. Otherwise turn the thermostat to a lower setting.

1. Close the gas supply valve.
 2. Allow the heater to burn off any fuel gas remaining in the gas supply line.
3. Set the thermostat to its lowest setting.
 4. Disconnect the heater from its gas and electrical supplies.

Variable Rate Valve

This heater includes a variable rate valve for adjusting the heat output from low to high heat, or anywhere in-between. See Figs. 7.

FIG. 7



Cleaning Instructions



WARNING Fire, Burn, and Explosion Hazard

- This heater contains electrical and mechanical components in the gas management, and safety systems.
- Such components may become inoperative or fail due to dust, dirt, wear and aging.
- Periodic cleaning and inspection as well as proper maintenance are essential to avoid serious injury or property damage.

1. Before cleaning, shut off all gas supply valves and disconnect electrical supply.
2. The heater should have dirt or dust removed periodically:

NOTE: Before each use clean the heater using compressed air or a soft brush or dry rag on its case and internal components. At this time, dust off the motor case to prevent the motor from over-heating. Also ensure the fan blade is free of material build-up.



WARNING

Do not use a pressure washer, water, or liquid cleaning solution on any gas controls. Use of a pressure washer, water, or liquid cleaning solution on the control components can cause severe personal injury or property damage due to water and/or liquids:

- In electrical components, and wires causing electrical shock or equipment failure.
- On gas control valves causing corrosion which can result in gas leaks and fire or explosion from the leak.

Clean all components of the heater with pressurized air, a dry brush, or a dry cloth.

Maintenance Instructions

1. The area surrounding the heater shall be kept clear and free from combustible materials, gasoline, and other flammable vapors and liquids.
2. Have your gas supplier check all gas piping annually for leaks or restrictions in gas lines.
3. Regulators must be periodically inspected to make sure the regulator vents are not blocked. Debris, insects, insect nests, snow, or ice on a regulator can block vents and cause excess pressure at the heater.
4. Regulators can wear out and function improperly. Have your gas supplier check the date codes on all regulators installed and check delivery pressures to the heater to make sure that the regulator is reliable.
5. Check all wiring, associated terminals, and electrical components within the heater for corrosion, frayed or cut insulation, tight connections, etc. Repair or replace as necessary.
6. Review all heater markings (i.e. wiring diagram, warnings, start-up, shut-down, troubleshooting, etc.) at the time of maintenance for legibility. Make sure none are cut, torn, or otherwise damaged. Any damaged markings must be replaced immediately by contacting the L.B. White Co., Inc. Dataplates, start-up and shut-down instructions and warnings are available at no cost. A nominal charge will be applied for wiring diagrams.

WARNING
Burn Hazard

- Heater surfaces are hot for a period of time after the heater has been shut down.
- Allow the heater to cool before performing service, maintenance, or cleaning.
- Failure to follow this warning will result in burns causing injury.

WARNING
Fire and Explosion Hazard

- Do not disassemble or attempt to repair any heater components or gas train components.
- All component parts must be replaced if defects are found.
- Failure to follow this warning will result in fire or explosions, causing property damage, injury, or death.

1. Close the fuel supply valve to the heater and disconnect the electrical supply before servicing unless necessary for your service procedure.
2. Remove the heater's base bottom for access to electrical components and connections.
3. Disconnect the appropriate electrical leads for the component being replaced.

4. Remove the fan guard and motor/fan assembly for access to barrel components.
5. The auto reset limit switches, and thermostat can be tested by disconnecting the leads at the component, and placing a jumper connecting the leads together:
 - Reconnect the electrical supply and open fuel supply valves.
 - If the heater lights, the component is defective and must be replaced.
 - Do not leave the jumper on or operate the heater if the part is defective. Replace the part immediately.
 - An alternate method for checking the components is to perform a continuity check..
6. The air proving switch must not be jumpered. If jumpered, the ignition control will not allow heater operation. Test the air proving switch for continuity. If defective, replace the switch
7. For reassembly, reverse the respective service procedure. Ensure gas connections are tightened securely.
8. After servicing, start the heater to ensure proper operation and check for gas leaks.
9. Clean the heater's orifice with compressed air or a soft, dry rag. Do not use files, drills, broaches, etc. to clean the orifice. Doing so may enlarge the hole, causing combustion or ignition problems. Replace the orifice if it cannot be cleaned properly.

MOTOR , FAN, AND AIR PROVING SWITCH

1. Remove fan guard and screws securing the motor mount to the heater's barrel. See Fig 8..
2. Lift motor/fan assembly from heater.

Fan

- Loosen set screw at hub.
- Pull fan from shaft.
- Ensure fan is flush on shaft end, and set screw is positioned over flat of motor shaft before tightening

FIG. 8

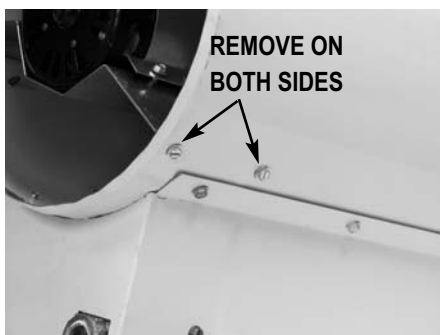

Motor

- Remove both screws and strap securing the motor.
- Position the motor between motor mount stops when reinstalling.

Air Proving Switch

- Remove screw securing switch bracket to motor mount.
- On reassembly, ensure tab on switch bracket is located in hole.

FIG. 9

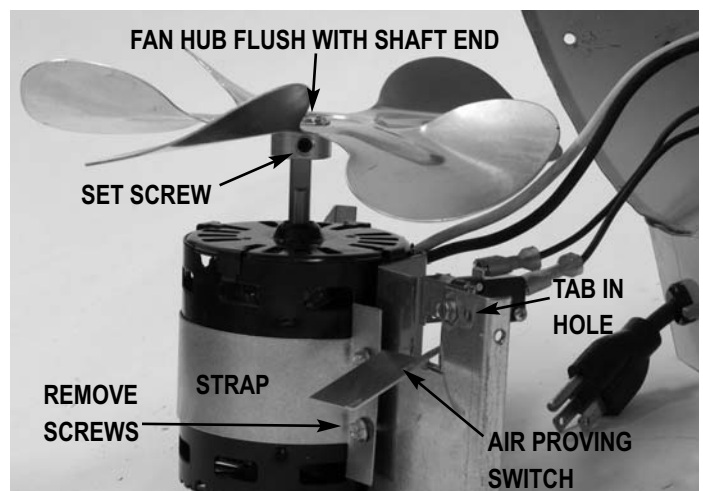

AUTO RESET LIMIT SWITCHES

There are two auto reset limit switches on this heater. One is located on the burner plate. The other is located on the underside of the combustion chamber. Either will cut off power to the gas control valve if the heater should overheat.

Switch mounted on burner plate. See Fig. 10.

- Remove the screws, spacers and nuts holding the switch to the burner plate.

FIG. 10

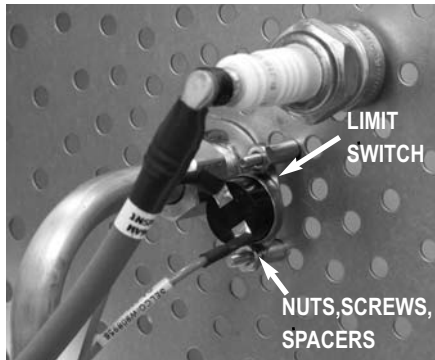

Switch mounted on underside of combustion chamber. (See Fig. 11.)

- Remove base bottom of heater.
- Remove screws securing the limit to the underside of the combustion chamber.
- The combustion chamber is stamped with the letters P (Propane) and N (Natural gas) adjacent to the screw holes to identify limit switch location for the appropriate gas.

FIG. 11

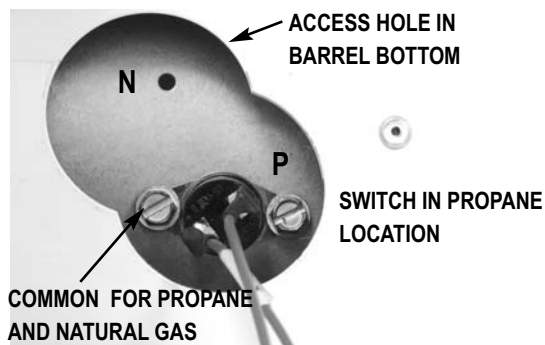

TESTING

The switches should be tested annually.

1. Remove the appropriate switch. Apply a small, soft flame to the sensing disk of the switch. See Fig. 12. Be careful not to melt the switch's plastic housing when conducting this test.
2. Within a short time, you should hear the contacts of the switch opening. Check for continuity across terminals to ensure the switch has opened.
3. Allow the switch to cool. The switch contacts will close. Check for electrical continuity across the switch terminals to ensure contacts have closed.

FIG. 12



VARIABLE RATE VALVE AND GAS CONTROL VALVE

1. Loosen the compression nut at the outlet of the variable rate valve. See Fig. 13.
2. Remove both screws securing the valve bracket to the heater side panel.
3. Remove the valve assembly from the heater and replace components as needed.

FIG. 13

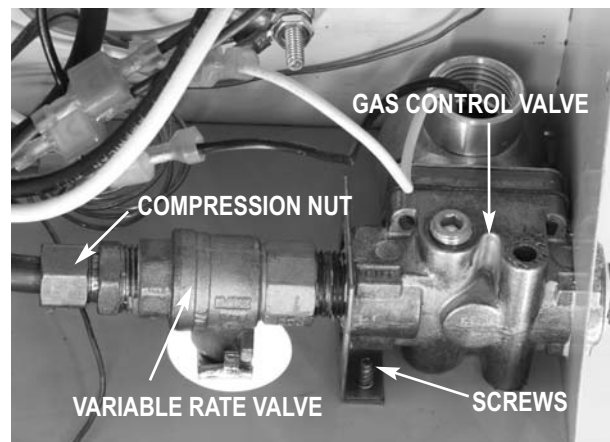

MAINTENANCE

1. Using a small wire brush, reach down the barrel of the heater and brush the igniter electrode. Remove any build up.
2. Ensure the igniter is positioned as shown. See Fig.14.
3. Periodically check the gap. Gap should be .10 as shown in Fig. 15.

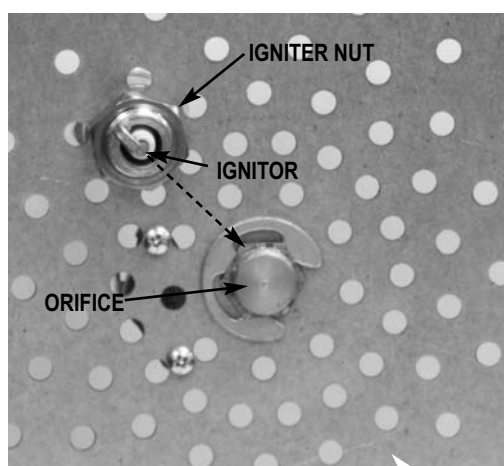
FIG. 14**FIG. 15****REMOVAL**

1. Disconnect the ignition cable from the igniter. See Fig.16.

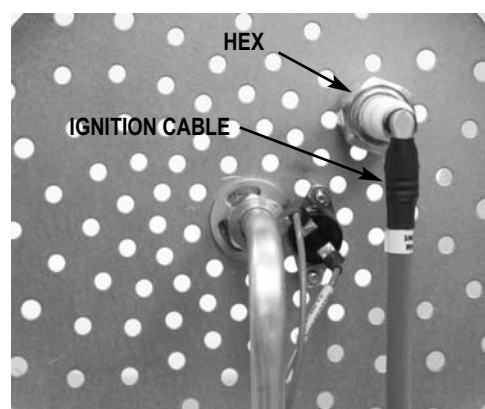
FIG. 16

2. Holding the igniter at its hex, (Fig. 16) reach in the heater's barrel and remove the igniter's mounting nut. See Fig 14. When replacing, ensure position and gap.

BURNER ORIFICE

1. Loosen the compression nut at the burner orifice. Remove the bowed retaining clip. See Fig. 17.
2. Reach down the barrel of the heater and pull the orifice from the burner plate.
3. Inspect the orifice and clean any plugged holes. Replace it if necessary. The replacement orifice will include retaining clips.

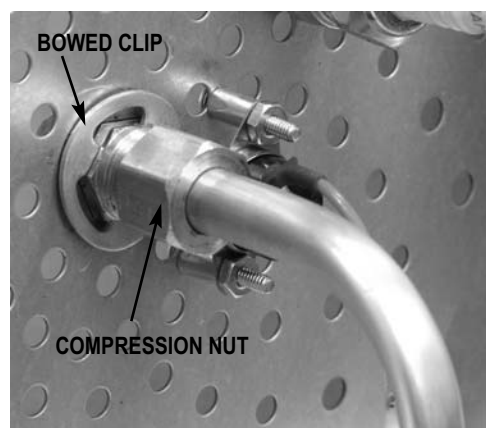
FIG. 17**FIG. 18**

THERMOSTAT

1. Remove knob and thermostat mounting screws. See Fig. 19.
2. Remove the base bottom from the heater.
3. Slide the thermostat sensing bulb from the cable tie at the wiring harness. See Fig. 20.

FIG. 19



FIG. 20

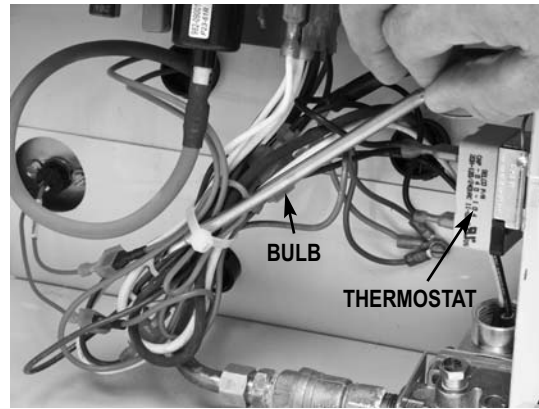

IGNITION CONTROL

1. Disconnect the LED wire harness from the circuit board, if applicable.
2. Disconnect the ignition cable and remove the nuts securing the control to the side of the heater's base. See Fig. 21.
3. When replacing, use care to prevent damage to the controller's components

FIG. 21

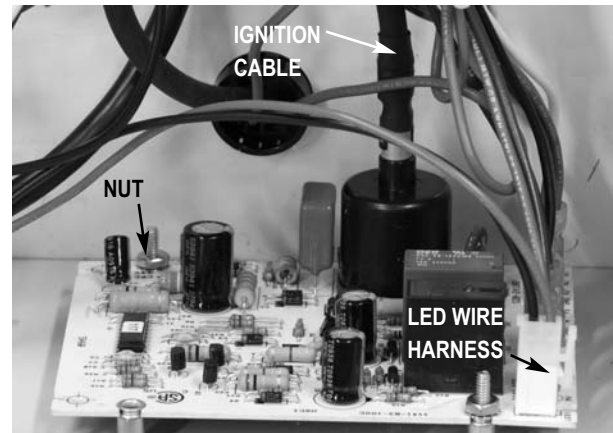

- The following explains a typical procedure to be followed in checking gas pressures.
- The gas pressures will vary depending upon fuel type.
- Consult the dataplate on the heater or page 4 in this manual for specific pressures to be used in conjunction with this procedure.
- Gas pressure measured at the gas control valve will verify proper inlet and burner manifold pressures.

A. Preparation

1. Obtain a pressure gauge capable of reading up to 35 in. W.C.
2. Disconnect the heater from the electrical supply and close the fuel supply valve to the heater inlet.
3. Remove the bottom base panel.
4. Brush or blow off any dust and dirt on or in the vicinity of the gas control valve.

B. Gauge Installation

1. Remove the pressure tap plug on gas control valve. See Fig. 22.

FIG. 22

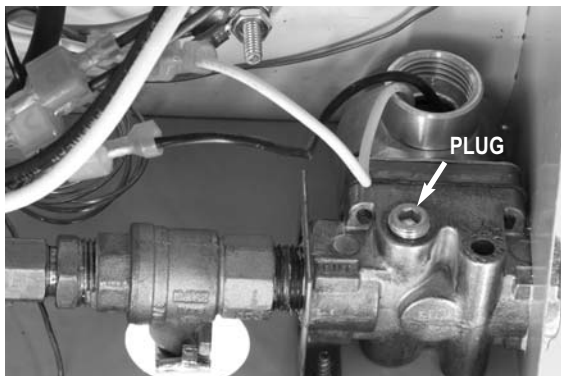

2. Install the gauge at the gas control.. See Fig. 23

FIG. 23

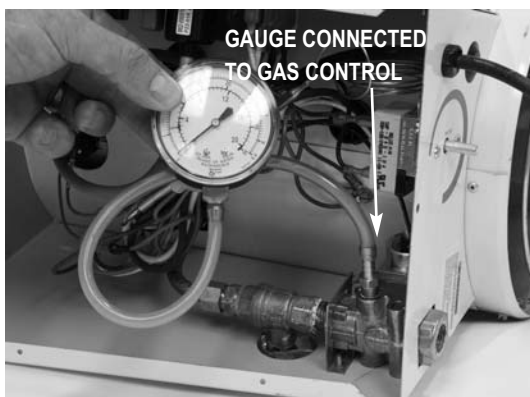

3. Position the heater upright. Lower the height adjustment leg to elevate the heater and prevent pinching of gauge hose See Fig. 24.

FIG. 24



C. Reading Pressures

1. With the heater operating, the pressure gauge must read the pressures specified on the dataplate
2. Does the reading at the gas control valve agree with that specified on the dataplate? If so, then no further checking or adjustment is required. Proceed to section D.
3. If the inlet pressures do not agree with that specified on the dataplate, then the regulator controlling gas pressure to the heater requires adjustment.

D. Completion

1. Once the proper pressure has been confirmed and/or properly set, close the fuel supply to the heater and allow the heater to burn off any gas remaining in the gas supply line.
2. Disconnect the heater from its electrical supply.
3. Remove the gauge.
4. Install pressure tap plug and tighten securely
5. Open the fuel supply and start the heater. Check for gas leaks at the plug Set heater's thermostat to desired temperature.

Troubleshooting Information

READ THIS ENTIRE SECTION BEFORE BEGINNING TO TROUBLESHOOT PROBLEMS.

WARNING

- This heater can start at any time.
- Troubleshooting this system may require operating the unit with voltage present and gas on. Be careful when working on the heater.
- Failure to follow this warning may result in property damage, personal injury or death.

The following troubleshooting guide provides systematic procedures for isolating equipment problems. This guide is intended for use by a **QUALIFIED GAS HEATER SERVICE PERSON. DO NOT ATTEMPT TO SERVICE THESE HEATERS UNLESS YOU HAVE BEEN PROPERLY TRAINED.**

TEST EQUIPMENT REQUIRED

The following pieces of test equipment will be required to troubleshoot this system with minimal time and effort.

- **Digital Multimeter** - for measuring AC voltage and resistance.
- **Low Pressure Gauge** - for checking inlet and outlet pressures at the gas control valve against dataplate rating.

Refer to the system operation sequence in this section to gain an understanding as to how the equipment operates during a call for heat. Understanding the sequence of operation is important as it relates to problem solving.

Heater models labeled **Tradesman Ultra** have a red light located at the fan end of the heater. The light will flash a specific pattern depending upon the problem which is diagnosed. If the light is flashing, the flash pattern will be followed by a pause and then a repeat of the flash pattern until the problem is corrected. Use the light to help diagnose the problem.

Heater models labeled **Tradesman** do not have the diagnostic red light.

Troubleshooting Flow Charts are provided to eliminate problems. To use the flow charts effectively, you must first identify the problem.

Before beginning::

- Inspect heater for apparent damage.
- Check all wiring for loose connections and worn insulation.

Tradesman Ultra Diagnostic Heaters	Page
Red light is steady on. No flash pattern.	19
Red light light is not on.	19
Red light is flashing:	
A. One Time	20
B. Two Times	21
C. Three Times.	22
D. Four Times.	22
D. Five Times	22

Tradesman Non - Diagnostic Heters	Page
Fan Does Not Run, Heater Does Not Light.	23
Fan Runs, Heater Does Not Light	24
Heater Lights, But Does Not Stay Lit	25

Components should be replaced only after each step has been completed and replacement is suggested in the flow chart. Refer to the Servicing sections as necessary to obtain information on disassembly and replacement procedures of the component once the problem is identified by the flow chart.

DIRECT IGNITION OPERATION SEQUENCE:

- Voltage is sent to the thermostat.
- Thermostat calls for heat.
- Thermostat sends voltage to ignition control.
- Red light is illuminated.(Diagnostic Heaters Only).
- Ignition control module performs self safety check.
 - Internal components are tested.
 - Air proving circuit is checked.
- Ignition control module begins ignition trial sequence.
- Ignition control module sends 115 volts to air proving switch.
- Ignition control sends 115 volts to motor, motor starts.
- Air proving switch closes and 115 volts are returned to the ignition control module.
- Ignition control module sends high voltage to the igniter electrode.
 - Igniter sparks.
- Ignition control module sends 115 volts to the gas control valve through the auto reset limit switches.
 - Gas control valve opens.
- Ignition occurs.
 - Igniter continues to spark until flame proving occurs.
 - Ignition spark is cut off.
 - Gas valve stays open.
- Room warms to desired temperature.
 - Thermostat is satisfied.
 - Heater shuts down.
- Process starts again on a call for heat.

IGNITION FAILURE SEQUENCE:

- Trial for ignition takes approximately 10 seconds.
- If ignition module does not sense a flame within the ignition trial, the module goes into safety lockout (3 flash pattern.)
 - Gas valve closes.
 - Ignition spark shuts off.
 - Fan motor stops.
- To retry for ignition, the systems must be reset:
 - Turn the thermostat down and then up to call for heat
 - or unplug heater and plug it back in or
 - Position selector switch to off and then back to on.

Red Light Constant On → Normal Operation

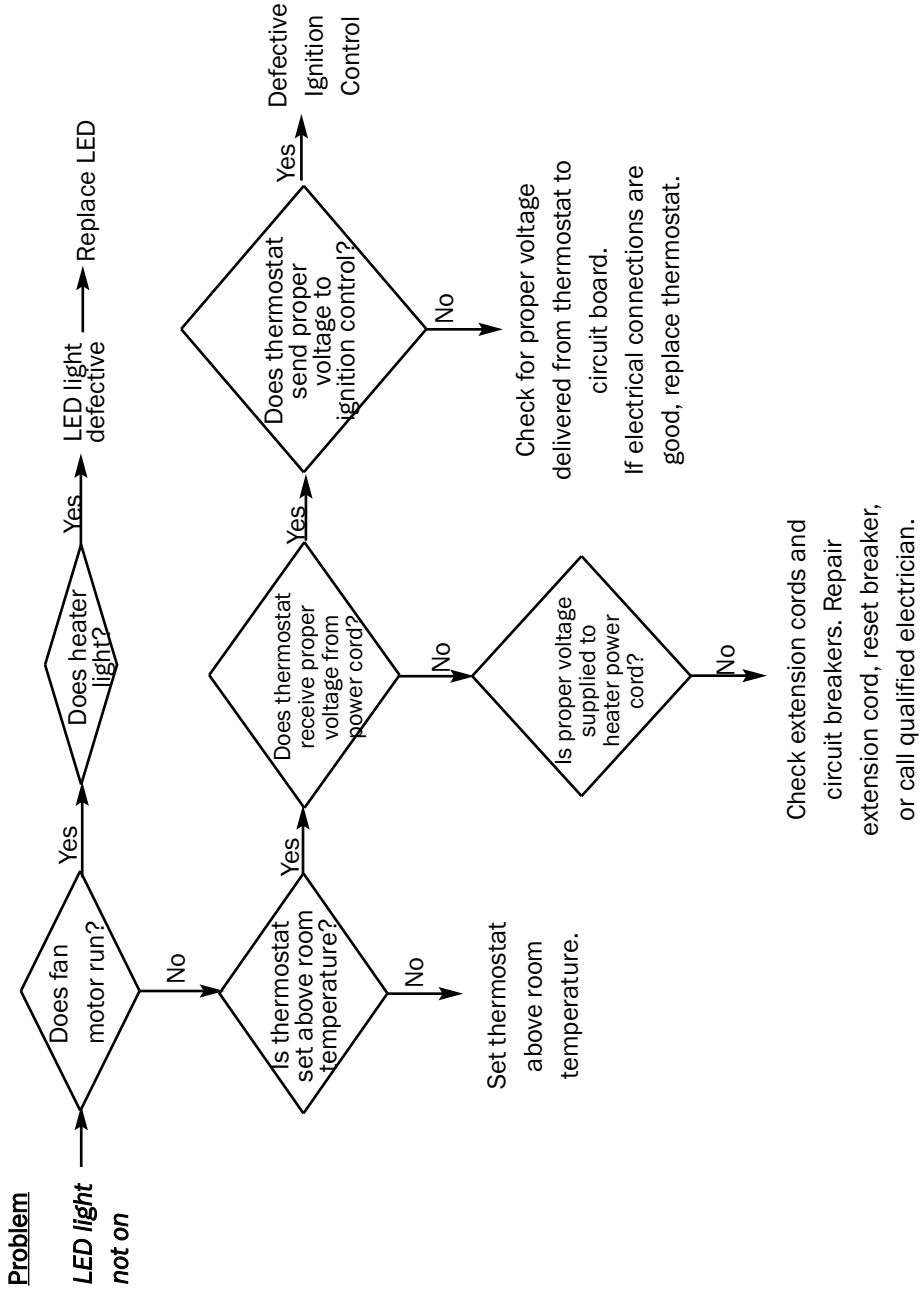

TRADESMAN ULTRA HEATER

Problem

LED Flashing

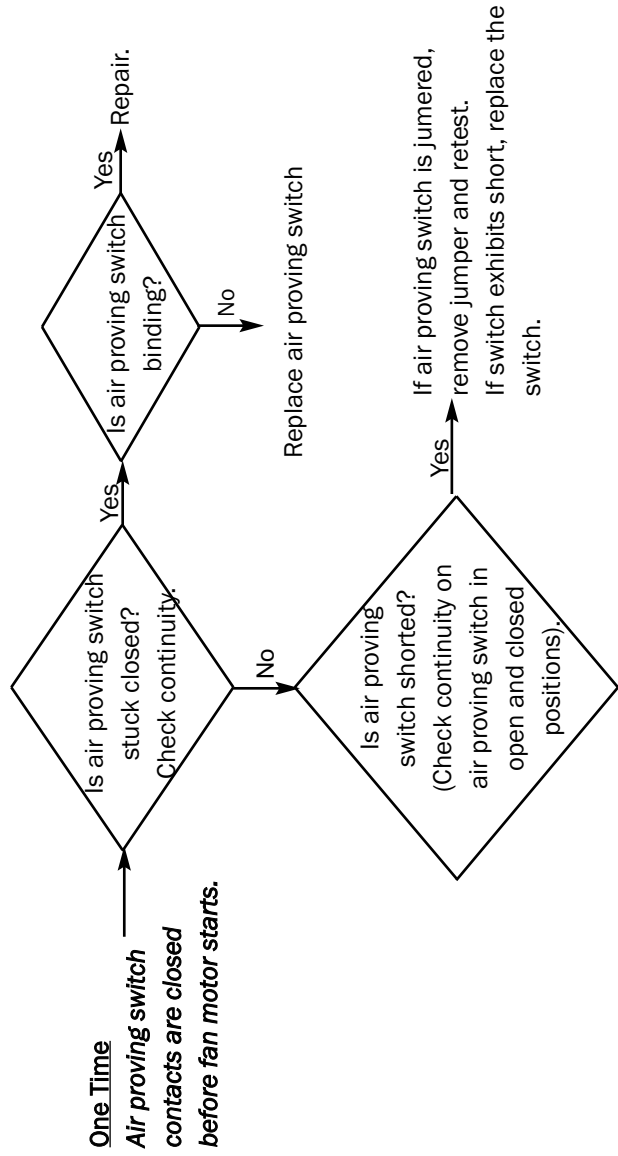

Problem

Three Times
Indicates ignition failure. The ignition control is in safety lockout..

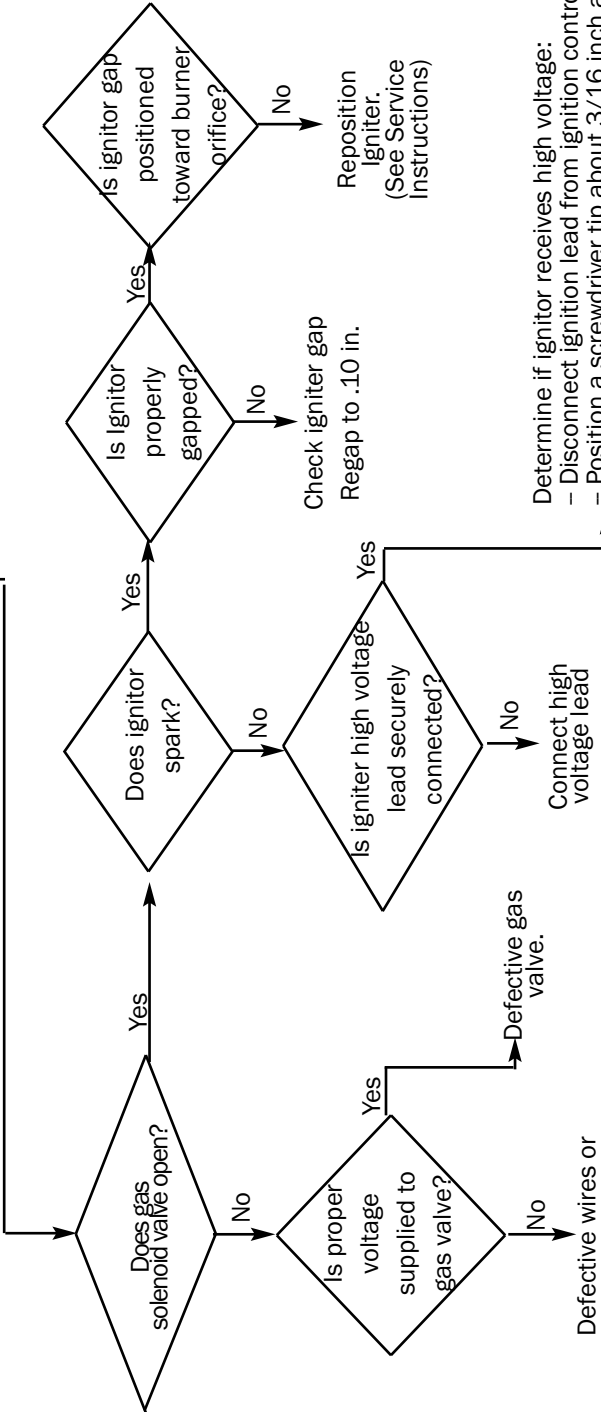
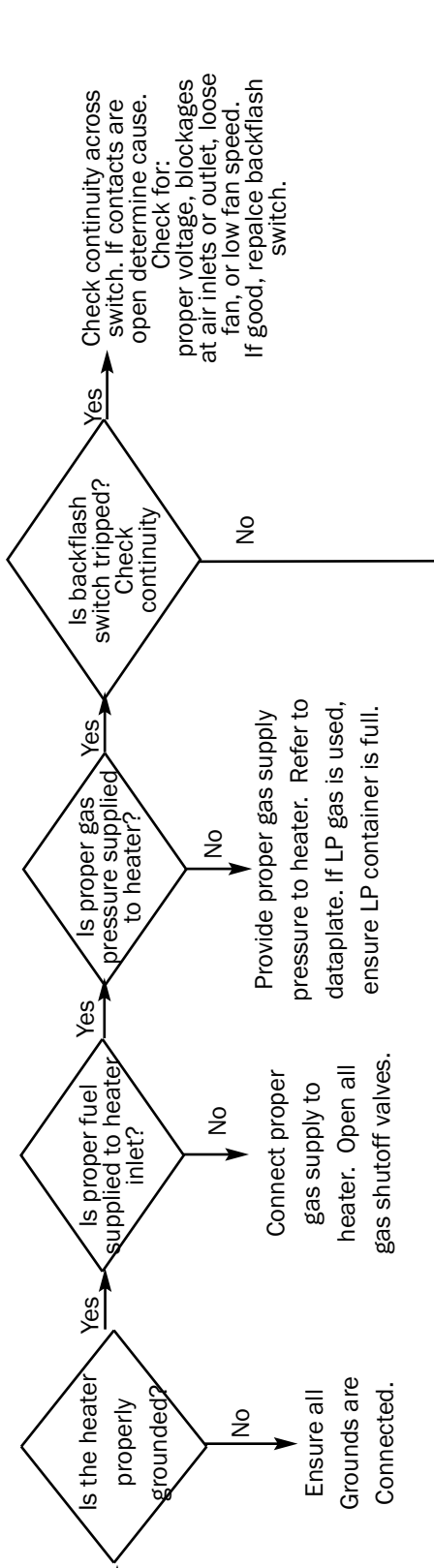

Determine if ignitor receives high voltage:
 - Disconnect ignition lead from ignition control.
 - Position a screwdriver tip about 3/16 inch away from ignition control where lead was connected.
 - WITH GAS OFF, start the heater.
 - If no spark is seen, replace the ignitor lead.
 - Disconnect the lead at the ignitor.
 - Hold the lead about 3/16 in. from a grounded section of the heater.
 - WITH GAS OFF, start the heater.
 - If no spark is observed, replace the ignition lead.
 - If spark is observed, replace the ignitor.

Four Times
Rapid On/Off cycling of the burner.
 → If control module does not reset, then replace the it (Internal board fault.)
 If module resets, then have qualified electrician check power source for power quality problems. (Frequency, line noise, line spikes, loose connections, too small wire gauge.)

Five Times
 → Flame sense related problems. Check for cracked or dirty flame sensor, improperly positioned sensor, or poor flame sense ground.

TRADESMAN HEATER

Problem

Fan motor does not run, heater does not light.

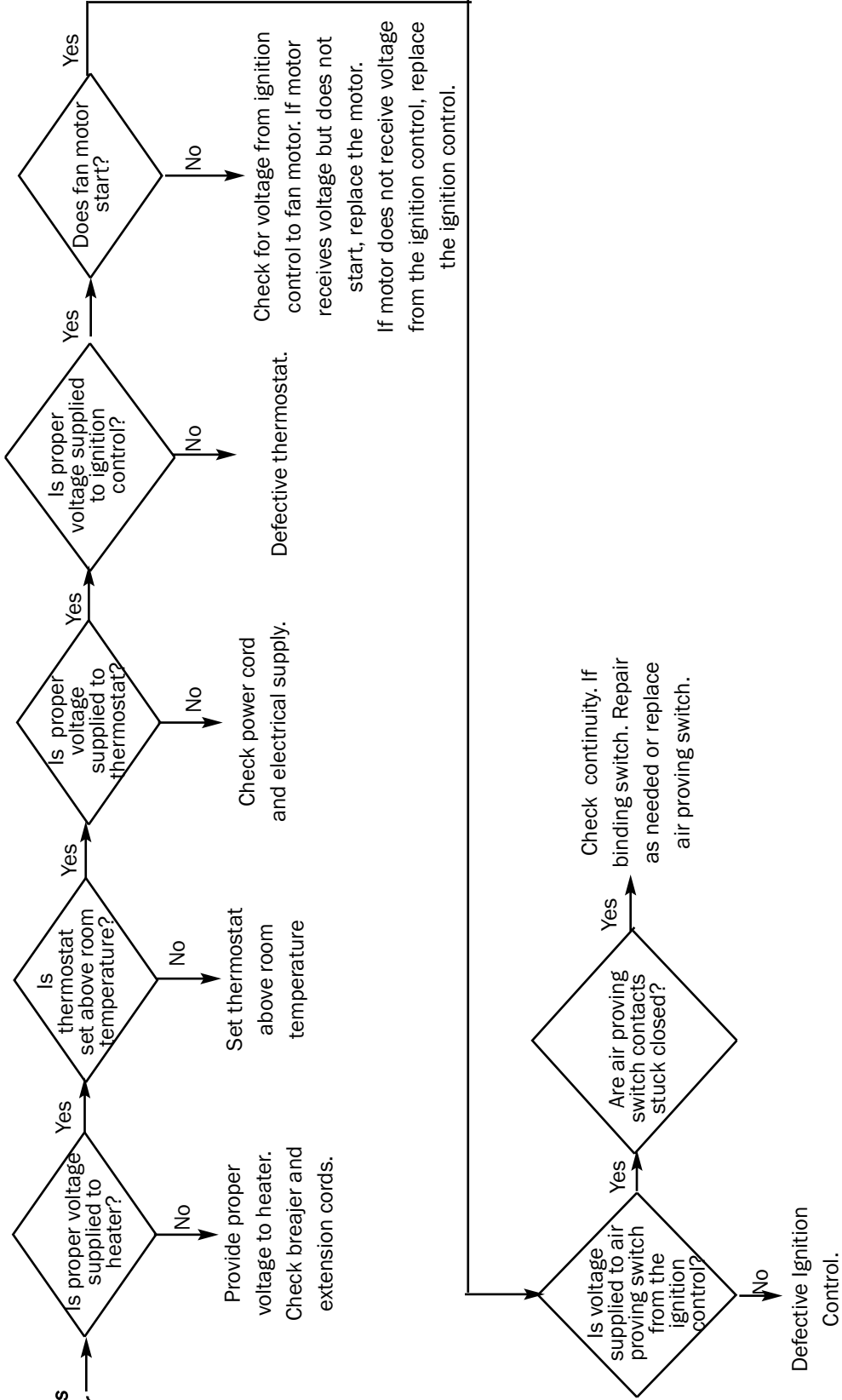

TRADESMAN HEATER

Problem

Fan runs, heater does not light.

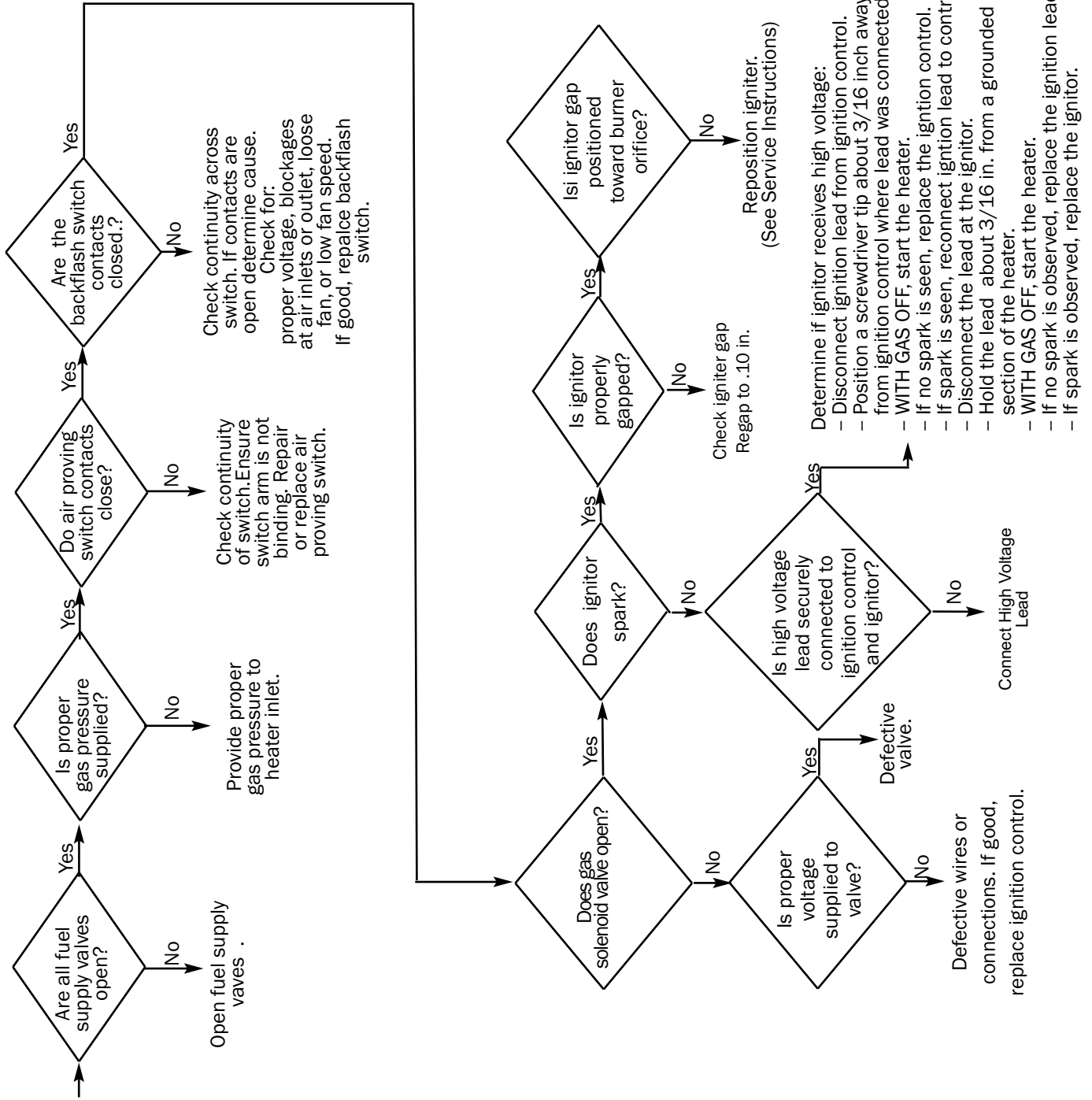

- Determine if ignitor receives high voltage:
- Disconnect ignition lead from ignition control.
 - Position a screwdriver tip about 3/16 inch away from ignition control where lead was connected.
 - WITH GAS OFF, start the heater.
 - If no spark is seen, replace the ignition control.
 - If spark is seen, reconnect ignition lead to control.
 - Disconnect the lead at the ignitor.
 - Hold the lead about 3/16 in. from a grounded section of the heater.
 - WITH GAS OFF, start the heater.
 - If no spark is observed, replace the ignitor.
 - If spark is observed, replace the ignitor.

TRADESMAN HEATER

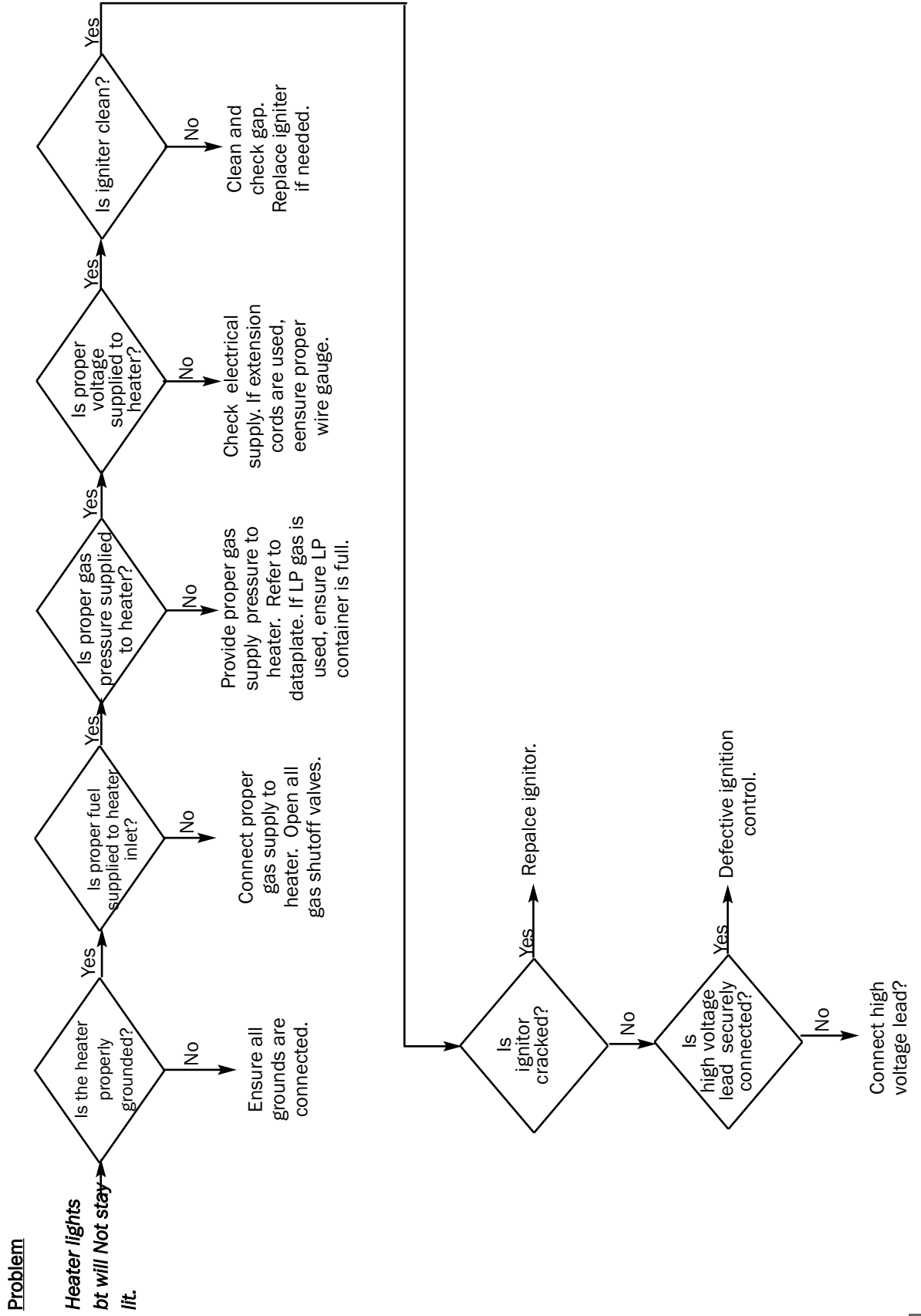

Heater Component Function

Air Proving Switch

Safety device used to insure that the proper air flow is being achieved before the gas valve is opened.

Auto Reset Limit Switch

Safety device wired into the control system which is used to break an electrical circuit to the gas control valve in event of overheat situation.

Burner

Component used to channel gas and provide an area at which the fuel may ignite.

Burner Orifice

Brass metering device used to feed gas to burner at a specific rate.

Combustion Chamber

Metal chamber within heater that provides an area where burner gas mixes with combustion air, thereby providing heat.

Direct Spark Ignition Control Module

Electronic printed circuit board which sends and receives voltages to various controls in an automatic ignition system. An important safety feature of the control board is that it will shut down the entire heater, thereby stopping the flow of fuel gas if burner flame goes out.

Fan

Component used in conjunction with the motor to pull the fresh air into the heater and blow it into room for heating

Gas Control Solenoid Valve

House an electromagnet which is energized by voltage and opens to allow passage of gas to the burner orifice.

Gas Hose

Flexible connector used to convey gas from supply line in building to heater.

Igniter

Ignition device used on automatic direct spark ignition control systems. Ignites gas by spark.

Igniter Wire

Cable used to provide high voltage to the igniter and also a pathway for flame sense current.

Motor

Electric device used to force preheated air through the heater and to circulate heat within a certain area. Converts electrical energy into mechanical energy.

Regulator

Mechanical device used in gas distribution systems to reduce a higher inlet pressure to a preset lower pressure. The regulator is responsible to supply a steady outlet pressure to the heater(s) despite changes in inlet pressure, heater demand and weather conditions.

Thermostat

Electrical device used as an automatic "on/off" switch which will respond to changes in temperature in a certain area.

Parts Identification

PARTS SCHEMATIC

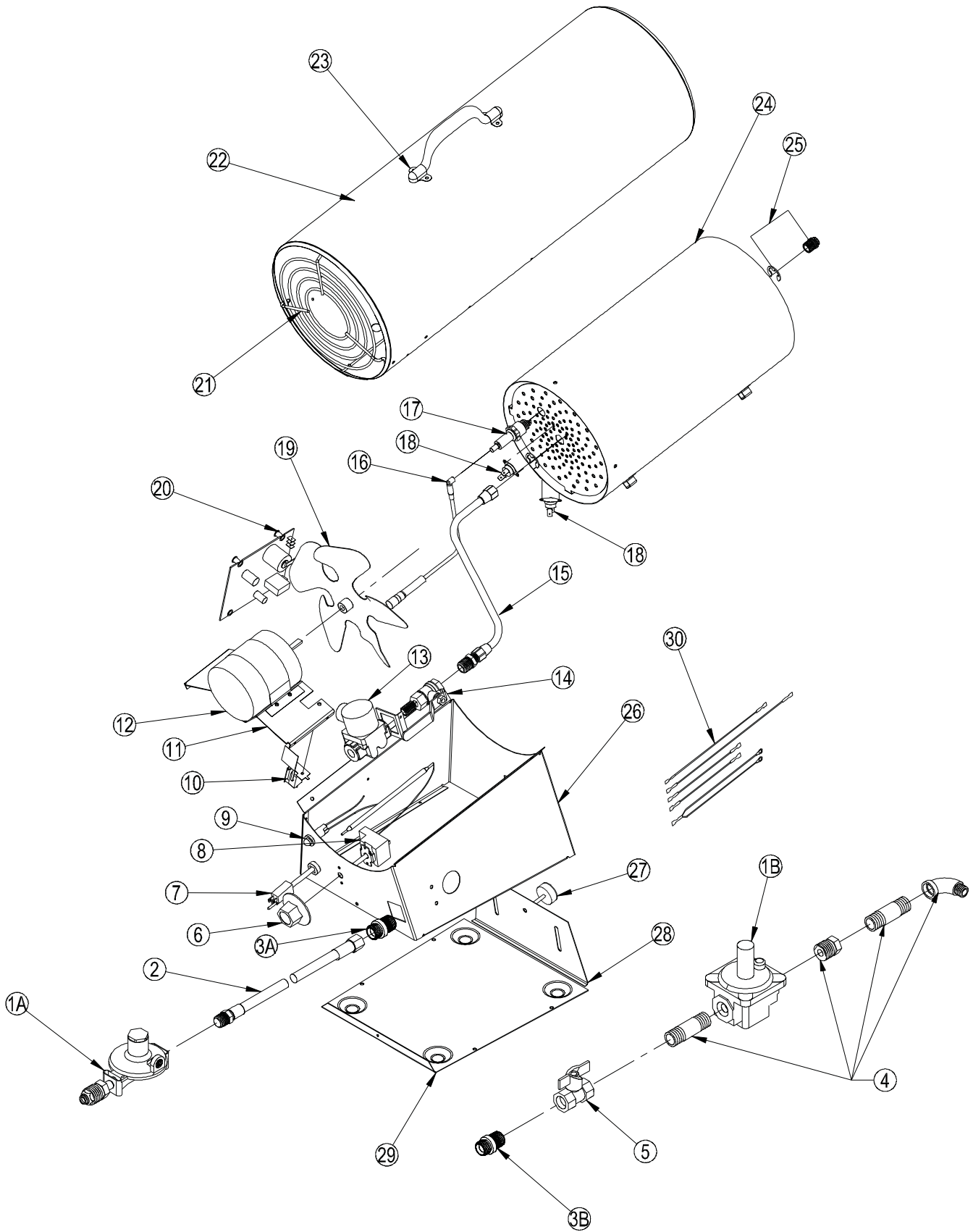

PARTS LIST

Item	Description	Part Number	
		Tradesman 170	Tradesman 170 ULTRA
1A	Regulator with POL (Propane Gas)		21856
1B	Regulator (Natural Gas)		06713
2	Hose, Fixed X Swivel, 3/8 in. x 10 ft. (Propane gas)		21841
	Hose, Fixed X Swivel, 1/2 in. x 10 ft. (Natural gas) Accessory		20504
3A	Adaptor, Hose, 3/8 in. (Propane Gas)		572517
3B	Adaptor, Hose, 1/2 in. (Natural Gas) Accessory		25873
4	Nipples,bushing, and ell		572535
5	Manual shut off valve		571173
6	Knob, thermostat		572514
7	Power cord		571356
8	Thermostat w/knob		571119
9	Lens, LED	—	571333
10	Air proving switch		06739
11	Motor mount w/strap		572516
12	Motor		571229
13	Gas control valve with bracket		572520
14	Variable rate valve with nipple		572519
15	Manifold tube with fittings		572518
16	Ignition cable, high voltage		571263
17	Igniter with nut		07160
18	Auto reset limit switch		572515
19	Fan blade		571238
20	Ignition control		571344
21	Fan guard		572521
22	Barrel assembly with fan guard	572523	572524
23	Handle assembly with screws		572522
24	Combustion chamber with limit switches, orifice, and igniter		
	(Propane gas)		572525
	(Natural gas)		572526
25	Burner orifice with retaining clips		572527
	(Natural gas)		572528
26	Case assembly, lower, with base, with leg and knob		
	(Propane gas)	572513	572531
	(Natural gas)	572530	572532
27	Knob, height adjustment		572529
28	Leg, with adjustment knob		572536
29	Base	572533	572534
30	Wiring harness		572557

Warranty Policy

EQUIPMENT

L.B. White Co., Inc. warrants that the component parts of its heater are free from defects in material and workmanship, when properly installed, operated, and maintained in accordance with the Owner's Manual safety guides and labels contained with each unit. If, **within 12 months from the date of purchase by the end user**, any component is found to be defective, L.B. White Co., Inc. will at its option, repair or replace the defective part or heater, with a new part or heater, F.O.B., Onalaska, Wisconsin.

A warranty card on file at L.B. White will automatically qualify the heater and its component parts for warranty consideration. If a warranty card is not on file, a copy of the bill of sale will be required to establish warranty qualification. If neither is available, the warranty period will be 12 months from date of shipment from L. B. White.

PARTS

L.B. White Co., Inc. warrants that replacement parts purchased from the company and used on the appropriate L. B. White heater are free from defects both in material and workmanship for **12 months from the date of purchase by the end user**. Warranty is automatic if a component is found defective within 12 months of the date code marked on the part. If the defect occurs more than 12 months later than the date code but within 12 months from the date of purchase by the end user, a copy of a bill of sale will be required to establish warranty qualification.

The warranty set forth above is the exclusive warranty provided by L.B. White, and all other warranties, including any implied warranties or merchantability or fitness for a particular purpose, are expressly disclaimed. In the event any implied warranty is not hereby effectively disclaimed due to operation of law, such implied warranty is limited in

duration to the duration of the applicable warranty stated above. The remedies set forth above are the sole and exclusive remedies available hereunder. L.B. White will not be liable for any incidental or consequential damages directly or indirectly related to the sale, handling or use of the heater, and in any event L.B. White's liability in connection with the heater, including for claims based on negligence or strict liability, is limited to the purchase price.

Some states do not allow limitations on how long an implied warranty lasts, so the above limitation may not apply to you. Some states do not allow the exclusion or limitation of incidental or consequential damages, so the above limitation or exclusion may not apply to you. This warranty gives you specific legal rights, and you may also have other rights which vary from state to state.

Replacement Parts and Service

Contact your local L.B. White dealer for replacement parts and service or call the L.B. White Co., Inc. at (800) 345-7200 for assistance. Be sure that you have your heater model number and configuration number when calling.